

Poles of a Magnet

A magnet has two ends called **poles**: the **north pole** and the **south pole**. The magnetic forces of the magnet are strongest at the poles.



When two magnets are brought close together, they will **attract** or **repel**, depending on which poles are brought together:

- **Like poles** will **repel** one another e.g. N-N or S-S.
- **Opposite poles** will **attract** e.g. N-S.

The forces exerted between the poles of two magnets are a type of **non-contact force**: the magnets do not have to be touching for the effect to be observed.

Remember that only **iron**, **cobalt** and **nickel** (or alloys containing these metals) are magnetic.

A **permanent magnet** is one with its own magnetic field. The magnetism cannot be turned on or off e.g. a bar magnet or a horseshoe magnet.

An **induced magnet** is a material which becomes magnetic only when placed within a magnetic field. Induced magnets only attract other materials and lose most (if not all) of their magnetism when removed from the magnetic field e.g. iron filings.

Magnetic Fields

The **magnetic field** is the area surrounding a magnet where the force is acting on another magnet or magnetic material. It can be observed using a compass placed at different points around a bar magnet. The field lines can be drawn by using the compass to mark the direction at a range of points.

A magnet always causes a magnetic material to be **attracted**. The strength of the magnetic field is determined by the proximity to the magnet.

When looking at a diagram of magnetic field lines, the force is strongest where the lines are closest together. The magnetic field of the magnet is strongest at the poles. The direction of the magnetic field shows the direction the force would act on another north pole.

As a result, magnetic field lines always come away from the north pole (like poles repel) and towards the south pole (unlike poles attract).

The earth produces a magnetic field and a magnetic compass uses this to help aid navigation. The core of the earth is made of iron (a magnetic material). A compass contains a small bar magnet shaped as a needle, which points in the direction of the earth's magnetic field.

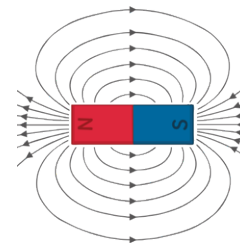

Plotting Magnetic Field Lines

A magnetic compass can be used to plot and draw the magnetic field lines around a magnet.

You should be able to describe this method for a bar magnet.

1. Place the bar magnet in the centre of a sheet of plain paper.
2. Using a magnetic compass, position it on the paper somewhere around the magnet.
3. Observe the direction of the needle and carefully draw a dot at the circumference of the magnet, in line with each end of the needle. Make sure you include an arrow to indicate the direction of north.
4. Repeat steps 2 and 3 for several positions around the magnet.
5. Join the arrows to complete the magnetic field lines and whole pattern.

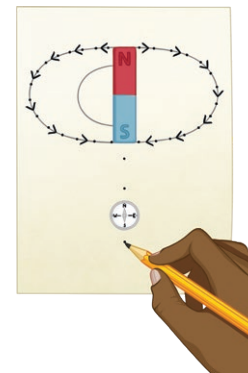

Electromagnetism

A circular **magnetic field** is produced when a current is passed through a conducting wire. This produces an **induced magnet**.

Switching off the current causes the magnetism to be lost.

The strength of the magnetic field can be increased by increasing the current flowing through the wire. The strength of the magnetic field is stronger closer to the wire.

Coiling the wire to form a **solenoid** will also increase the strength of the magnetic field. The strength of the magnetic field created by a solenoid is strong and uniform throughout.

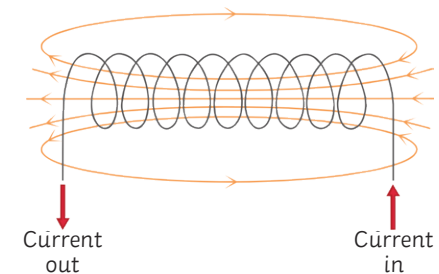

To increase the strength of the magnetic field around a solenoid you can...

- add an iron core;
- increase the number of turns in the coil;
- increase the current passing through the wire.

An **electromagnet** is a solenoid with an iron core. Electromagnets are **induced magnets** and can be turned on and off.

Electric motors, loudspeakers, electric bells and remotely controlled door locks all use **electromagnets**.

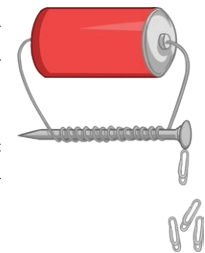

The Motor Effect and Fleming's Left-Hand Rule

When a wire carrying a current is exposed to the magnetic field of another magnet, then a **force** is produced on the wire at a **right angle** to the direction of the magnetic field produced.

This is called the **motor effect**.

The force produced by the motor effect can be calculated using this equation:

$$\text{force (N)} = \text{magnetic flux density (T)} \times \text{current (A)} \times \text{length (m)}$$

For example:

A current of 8A is flowing through a wire that is 75cm long. The magnetic field acting at a right angle on the wire is 0.5T. Calculate the force.

$$F = B \times I \times l$$

Remember: the equation uses length measured in m. The question gives you the length in cm so you need to convert it before you calculate your answer.

$$F = 0.5 \times 8 \times 0.75$$

$$F = 3\text{N}$$

From the equation we can see that the force acting on a given length of wire (e.g. 1m) will be increased if the current increases or the magnetic flux density increases.

If the current flowing through a wire is **parallel** to the magnetic field, then **no force** is produced – there is no motor effect.

You might be shown a diagram and asked to indicate the direction of the force produced.

Fleming's left-hand rule can help you do this because it represents the **relative orientation** of the force produced by the motor effect.

Remember:

- Use your **left hand!**
- The angle between your index finger and middle finger should be a **right angle** on the horizontal plane.
- The angle between your index finger and thumb should be a **right angle** on the vertical plane.
- Your **thumb** represents the direction of the **force**.
- Your **index finger** represents the direction of the **magnetic field**.
- Your **middle finger** represents the direction of the **current** flowing through the wire.

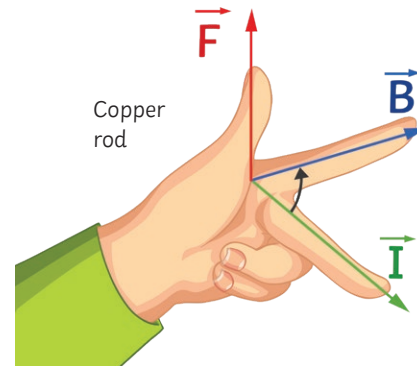
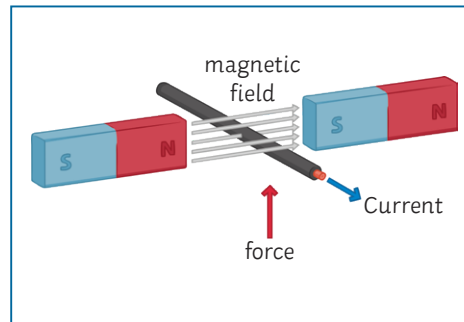
**Electric Motors**

When the wire carrying the current is **coiled**, the motor effect acting on it causes the wire to **rotate**. This is how an **electric motor** works.

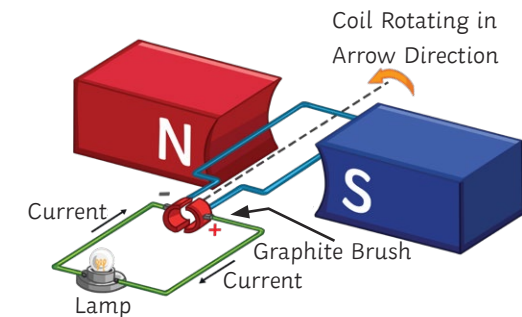

As the **current** flows (from negative to positive), the force produced in each side of the coil acts in **opposite directions**, causing the coil to **rotate** overall.

When the coil reaches a **vertical position**, the force produced is now **parallel** to the magnetic field line and so would be **zero**. This would cause the motor to stop rotating.

To maintain the rotation of the coiled wire, a **split ring commutator** is used to supply the current to the wire. The DC supply reaches the split ring via graphite or metal **brushes** which maintain the connection while allowing it to rotate freely on the **axle**.

The two halves of the split ring commutator ensure that the **current supplied** to the wire **changes direction** each half-turn (or that the current supplied is the same direction on each side of the motor) and as a result, the force produced maintains a **constant rotation** in one direction overall.